

Article number: 20171V402BL

Description: E+G

Corner base clamps GN167-V40-2-BL

## Measures

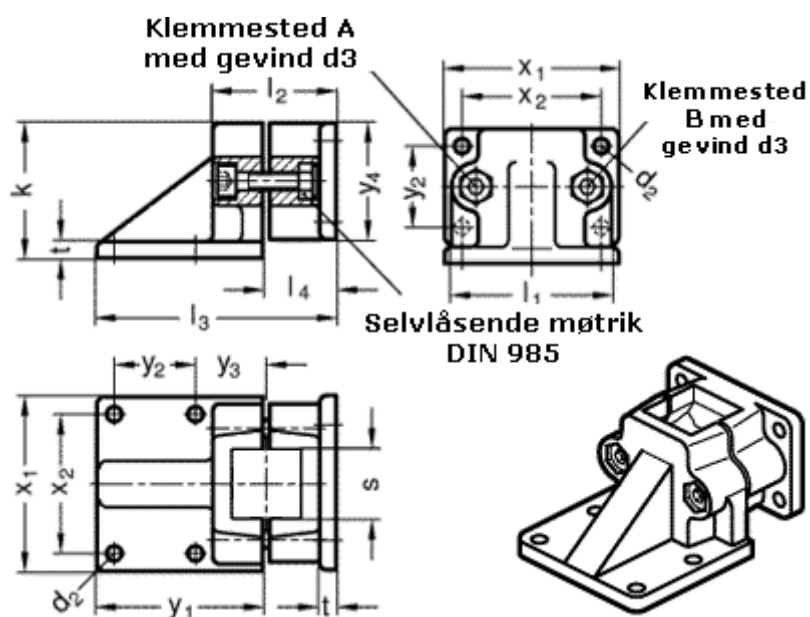

d2 = 11	t = 14
d3 = M10	x1 = 115
k = 91	x2 = 90
l1 = 98	y1 = 108
l2 = 82	y2 = 50
l3 = 156	y3 = 45
l4 = 47	y4 = 76
S = V40	